

DIN 2080, CORPO MANDRINO BILANCIATO, CON ASOLA DI ESTRAZIONE PER UTENSILI. EQUILIBRATURA 12.000 RPM.

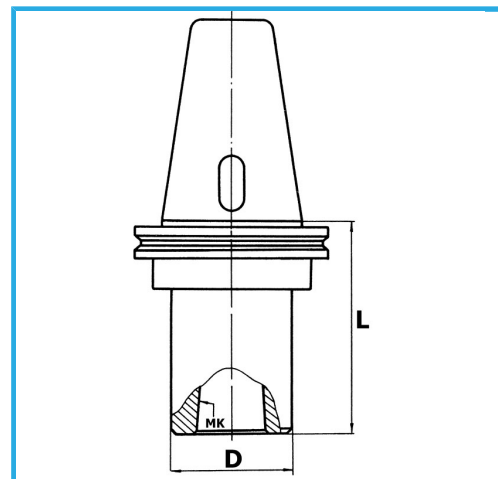

€161,00



ISO	50
CM	1
D	25 mm
L	45 mm
Peso lordo	0,97 kg
Codice EAN	8012667407186



Scatola



Rettificato