

DIN 2080, BALANCED CHUCK BODY, WITH EXTRACTION SLOT FOR TOOLS. BALANCING 12.000 RPM.

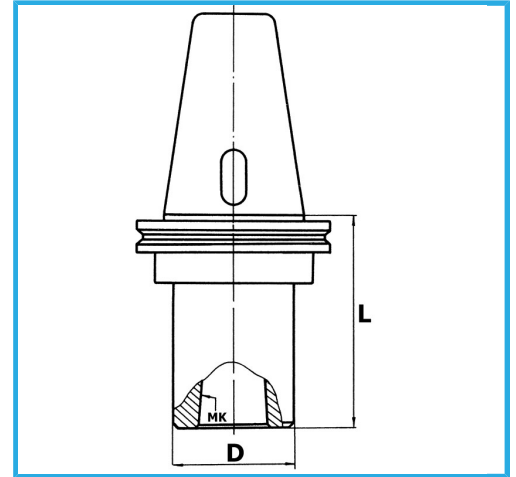

ISO	40
MT	2
D	32 mm
L	50 mm
Gross weight	0,97 kg
EAN Code	8012667407155



Box



Grounded