

DIN 2080, CORPO MANDRINO BILANCIATO, CON ASOLA DI ESTRAZIONE PER UTENSILI. EQUILIBRATURA 12.000 RPM.

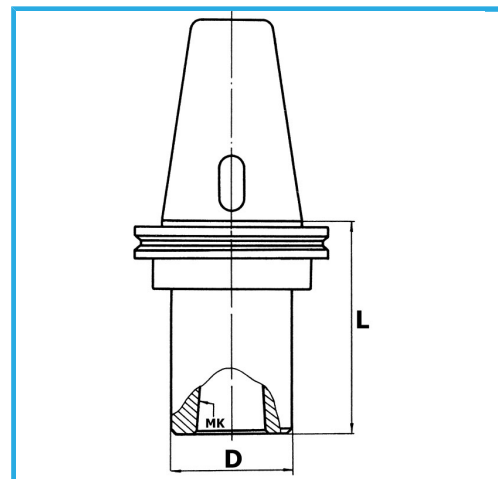

€109,00



ISO	40
CM	4
D	48 mm
L	95 mm
Peso lordo	0,97 kg
Codice EAN	8012667407179



Scatola



Rettificato