

DIN 2080, CON CUERPO EQUILIBRADO, CON RANURA DE EXTRACCIÓN PARA HERRAMIENTAS. EQUILIBRADO 12.000 RPM.

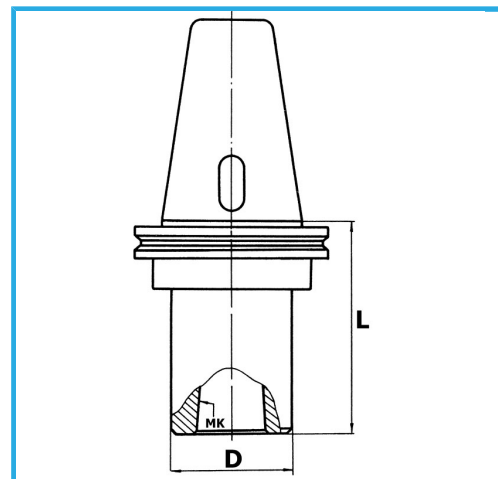

€161,00



ISO	50
CM	2
D	32 mm
L	60 mm
Peso bruto	0,97 kg
Codigo de barras	8012667407193



Caja



Rectificado