

DIN 2080, CORPO MANDRINO BILANCIATO, CON ASOLA DI ESTRAZIONE PER UTENSILI. EQUILIBRATURA 12.000 RPM.

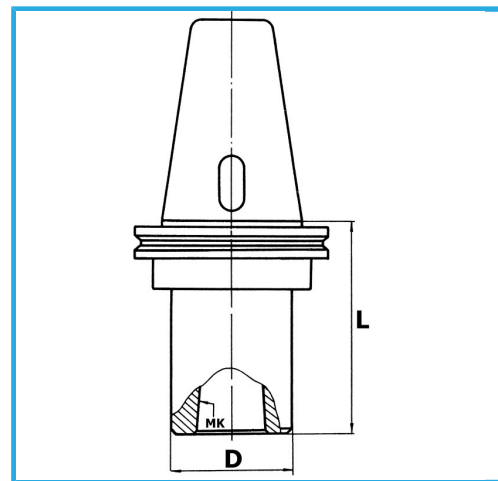

€161,00



ISO	50
CM	2
D	32 mm
L	60 mm
Peso lordo	0,97 kg
Codice EAN	8012667407193



Scatola



Rettificato