

DIN 2080, BALANCED CHUCK BODY, WITH EXTRACTION SLOT FOR TOOLS. BALANCING 12.000 RPM.

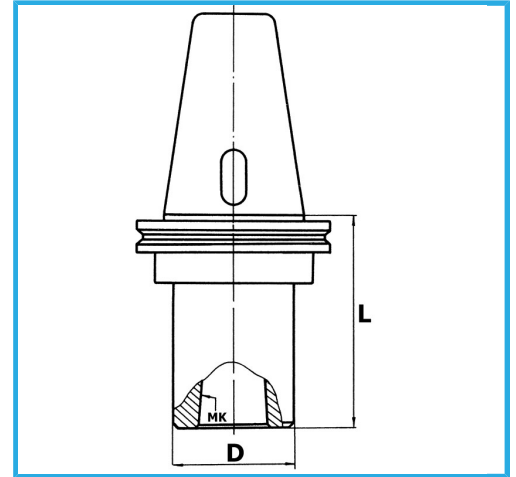

ISO	50
MT	4
D	48 mm
L	70 mm
Gross weight	0,97 kg
EAN Code	8012667407216



Box



Grounded