

DIN 2080, CON CUERPO EQUILIBRADO, CON RANURA DE EXTRACCIÓN PARA HERRAMIENTAS. EQUILIBRADO 12.000 RPM.

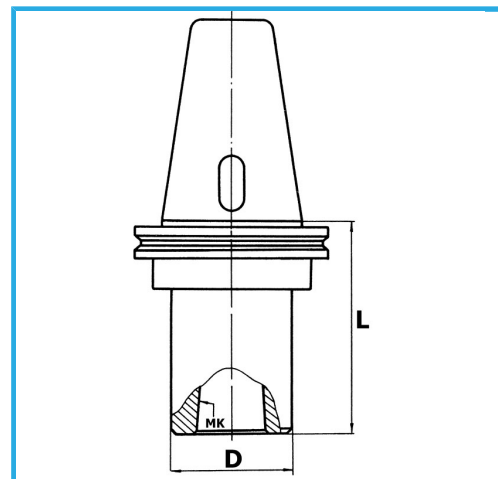

€180,00



ISO	50
CM	4
D	48 mm
L	70 mm
Peso bruto	0,97 kg
Codigo de barras	8012667407216



Caja



Rectificado