

SUITABLE FOR JOBS WHERE PRECISION, RELIABILITY, AVAILABILITY AND SECURE LOCKING ARE REQUIRED. SUITABLE FOR PRECISION MILLING AND..

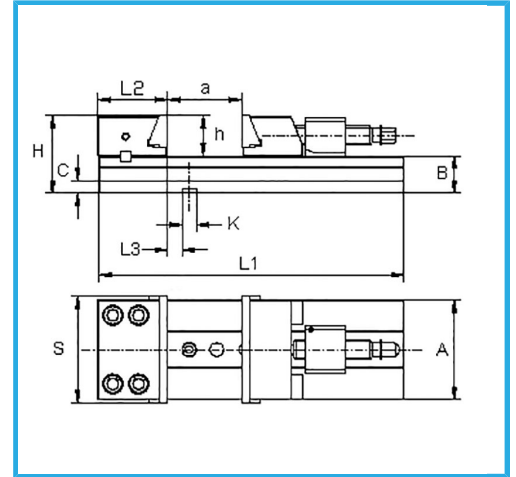

Jaw dimensions

Jaw dimensions	150 x 60h mm
S	150 mm
A	150 mm
B	50 mm
C	20 mm
H	110 mm
L1	525 mm
L2	93 mm
L3	25,6 mm
h	60 mm
K h7	16 mm
a	300 mm
Net weight	35 kg
Gross weight	40,00 kg
EAN Code	8012667191429

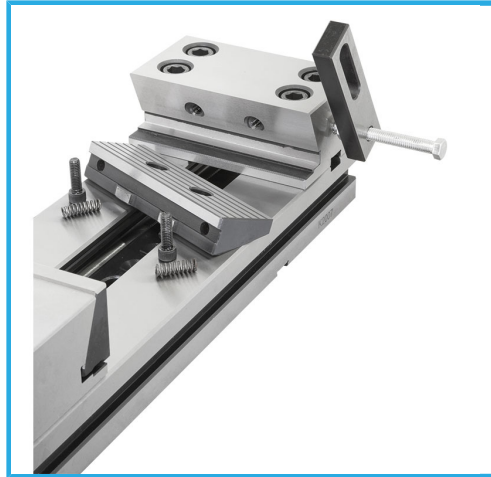
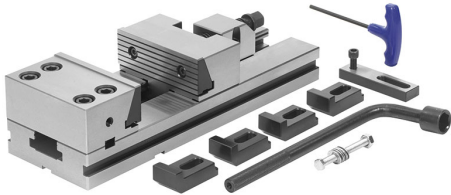

Wooden Box



Tempered



Steel



Grounded