

SUITABLE FOR JOBS WHERE PRECISION, RELIABILITY, AVAILABILITY AND SECURE LOCKING ARE REQUIRED. SUITABLE FOR PRECISION MILLING AND..

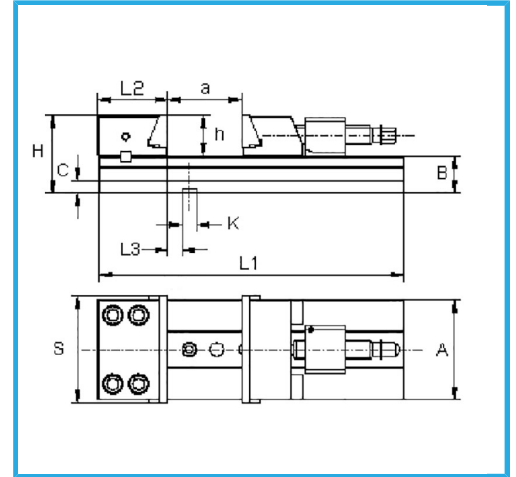

Jaw dimensions

S	100 mm
A	75 mm
B	35 mm
C	15 mm
H	65 mm
L1	270 mm
L2	77,9 mm
L3	25,6 mm
h	30 mm
K h7	16 mm
a	100 mm
Net weight	7 kg
Gross weight	9,76 kg
EAN Code	8012667245252

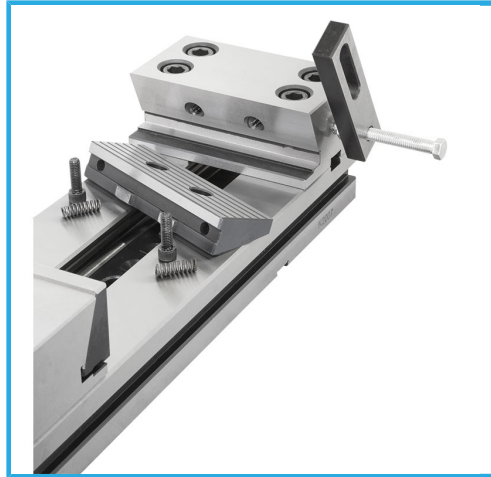
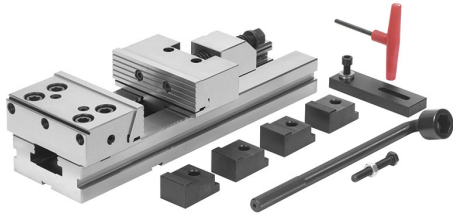

Wooden Box



Tempered



Grounded



Steel