

SUITABLE FOR JOBS WHERE PRECISION, RELIABILITY, AVAILABILITY AND SECURE LOCKING ARE REQUIRED. SUITABLE FOR PRECISION MILLING AND..

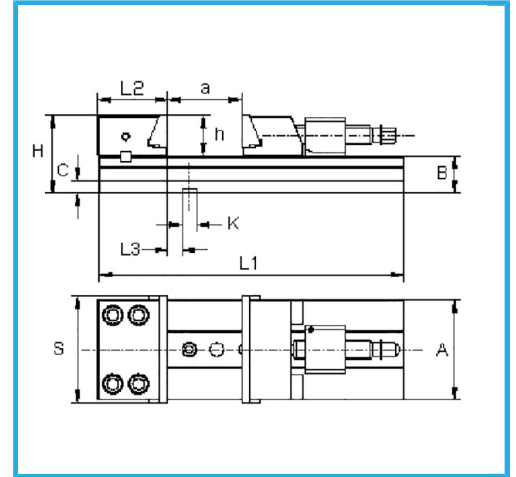

Jaw dimensions

	125 x 40h mm
S	125 mm
A	95 mm
B	40 mm
C	15 mm
H	80 mm
L1	345 mm
L2	77,9 mm
L3	25,6 mm
h	40 mm
K h7	16 mm
a	150 mm
Net weight	13 kg
Gross weight	16,78 kg
EAN Code	8012667245221

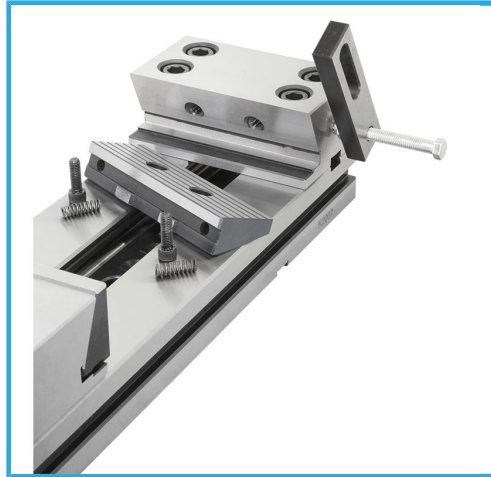
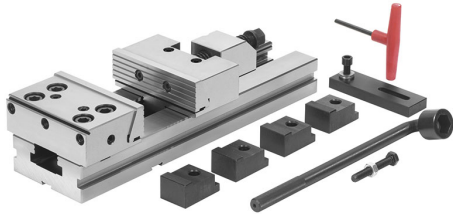

Wooden Box



Tempered



Grounded



Steel