

SUITABLE FOR JOBS WHERE PRECISION, RELIABILITY, AVAILABILITY AND SECURE LOCKING ARE REQUIRED. SUITABLE FOR PRECISION MILLING AND..

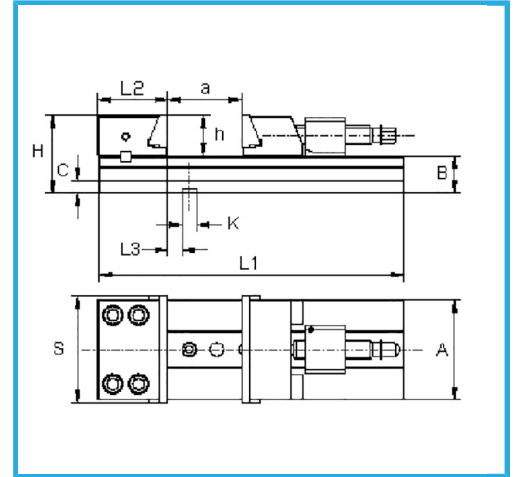

Jaw dimensions

	150 x 50h mm
S	150 mm
A	125 mm
B	50 mm
C	20 mm
H	100 mm
L1	420 mm
L2	89,4 mm
L3	25,6 mm
h	50 mm
K h7	16 mm
a	200 mm
Net weight	26 kg
Gross weight	31,00 kg
EAN Code	8012667245238

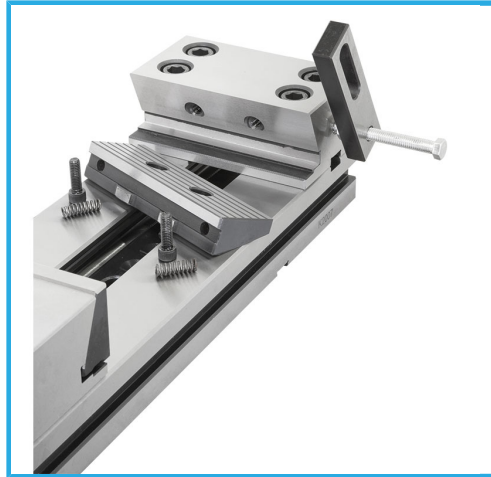
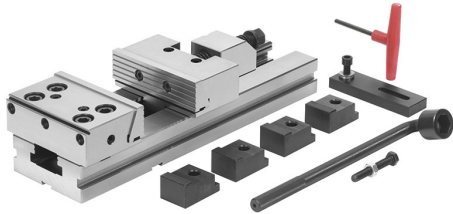

Wooden Box



Tempered



Grounded



Steel