

SUITABLE FOR JOBS WHERE PRECISION, RELIABILITY, AVAILABILITY AND SECURE LOCKING ARE REQUIRED. SUITABLE FOR PRECISION MILLING AND..

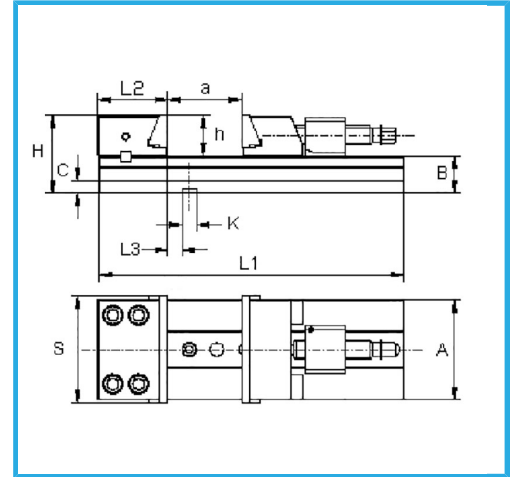

Jaw dimensions

S	175 mm
A	145 mm
B	58 mm
C	20 mm
H	118 mm
L1	455 mm
L2	96,9 mm
L3	25,6 mm
h	60 mm
K h7	16 mm
a	200 mm
Net weight	40 kg
Gross weight	45,50 kg
EAN Code	8012667254032

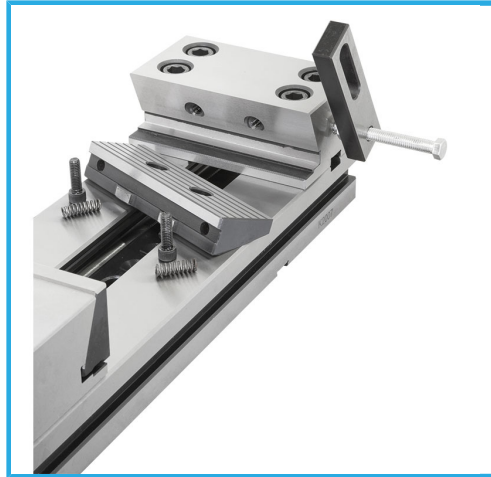
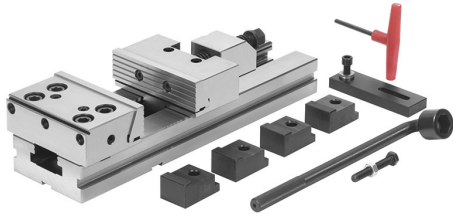

Wooden Box



Tempered



Grounded



Steel