

GEEIGNET FÜR ARBEITEN, BEI DENEN PRÄZISION, ZUVERLÄSSIGKEIT,  
 VERFÜGBARKEIT UND SICHERE VERRIEGELUNG...

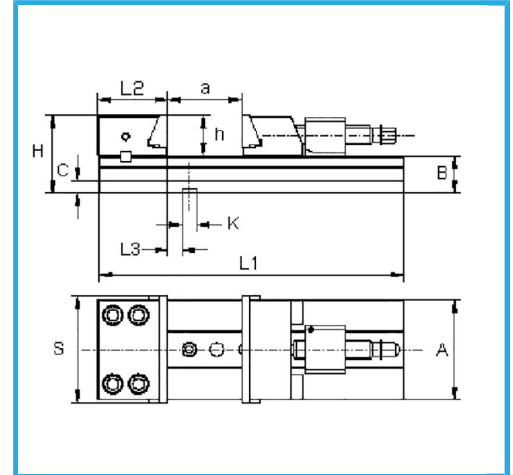

**Backenabmessungen**

S	175 mm
A	145 mm
B	58 mm
C	20 mm
H	118 mm
L1	555 mm
L2	96,9 mm
L3	25,6 mm
h	60 mm
K h7	16 mm
a	300 mm
<b>Nettogewicht</b>	<b>43 kg</b>
<b>Bruttogewicht</b>	<b>48,00 kg</b>
<b>EAN-Code</b>	<b>8012667253974</b>

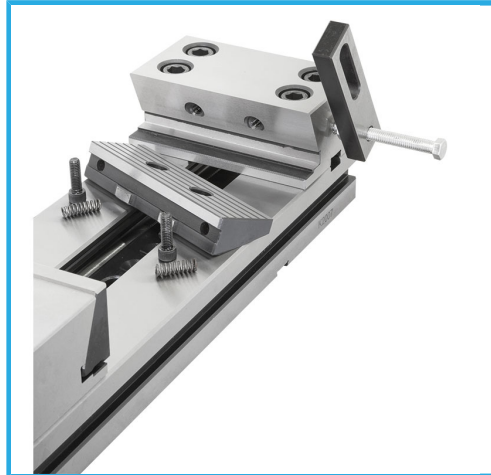
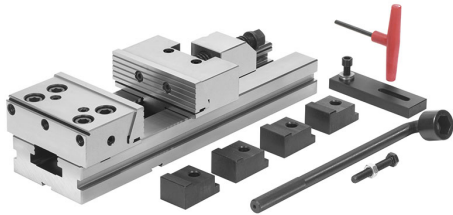

Holzkasten



Gehärteter



Korrigiert



Stahl