

GEEIGNET FÜR ARBEITEN, BEI DENEN PRÄZISION, ZUVERLÄSSIGKEIT,  
 VERFÜGBARKEIT UND SICHERE VERRIEGELUNG...

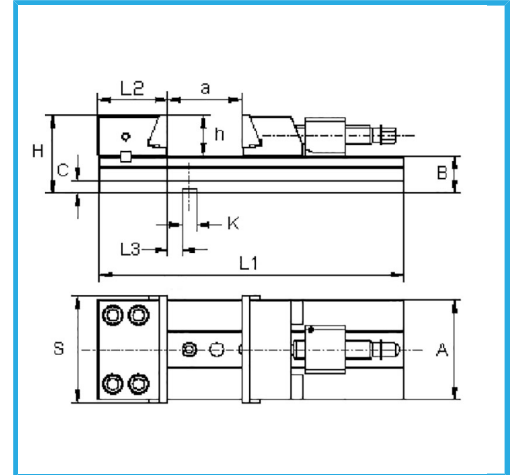

**Backenabmessungen**

S	175 mm
a	145 mm
B	58 mm
C	20 mm
H	118 mm
L1	655 mm
L2	96,9 mm
L3	25,6 mm
h	60 mm
K h7	16 mm
A	400 mm
<b>Nettogewicht</b>	50 kg
<b>Bruttogewicht</b>	55,50 kg
<b>EAN-Code</b>	8012667253981

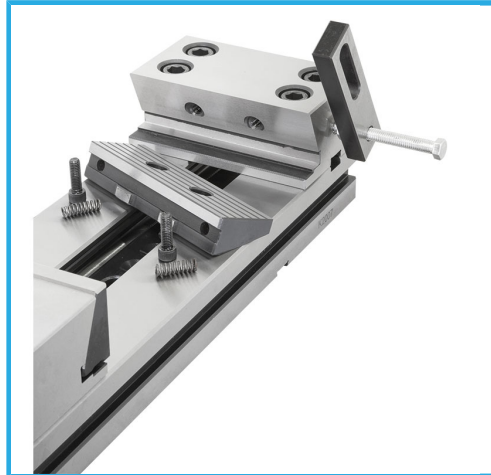
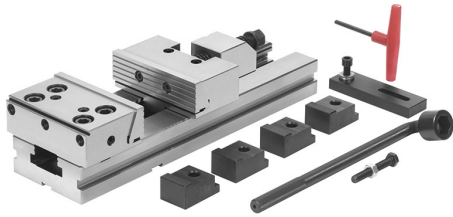

Holzkasten



Gehärteter



Korrigiert



Stahl