

GEEIGNET FÜR ARBEITEN, BEI DENEN PRÄZISION, ZUVERLÄSSIGKEIT,
VERFÜGBARKEIT UND SICHERE VERRIEGELUNG...

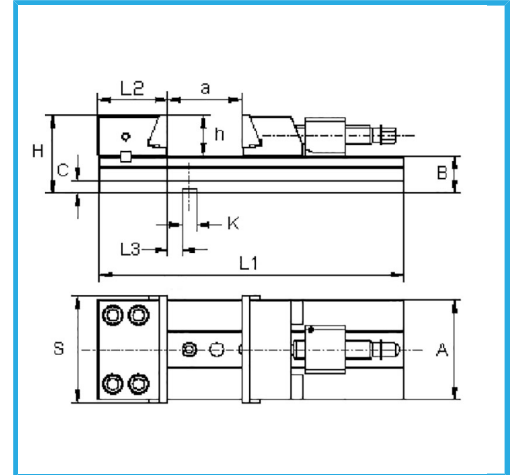

Backenabmessungen

S	200 mm
A	170 mm
B	70 mm
C	26 mm
H	135 mm
L1	595 mm
L2	113,4 mm
L3	25,6 mm
h	65 mm
K h7	16 mm
a	300 mm
Nettogewicht	69 kg
Bruttogewicht	80,00 kg
EAN-Code	8012667254049

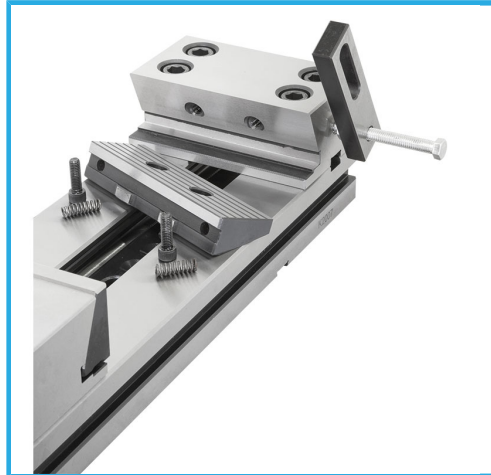
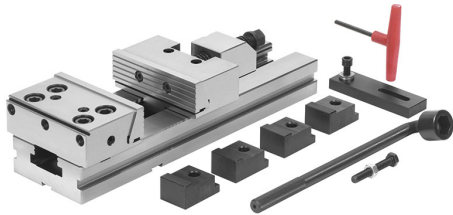

Holzkasten



Gehärteter



Korrigiert



Stahl