

SUITABLE FOR JOBS WHERE PRECISION, RELIABILITY, AVAILABILITY AND SECURE LOCKING ARE REQUIRED. SUITABLE FOR PRECISION MILLING AND..

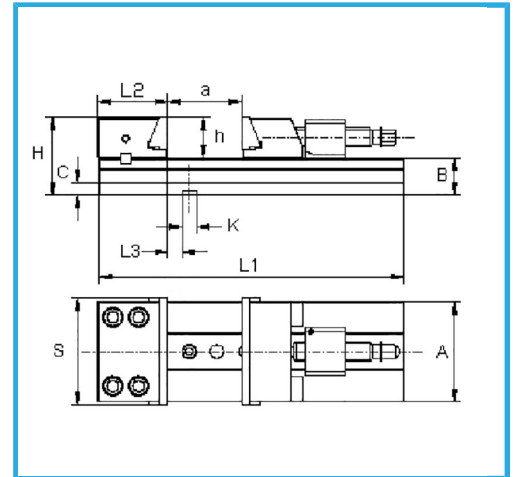

Jaw dimensions	200 x 65h mm
S	200 mm
A	170 mm
B	70 mm
C	26 mm
H	135 mm
L1	795 mm
L2	113,4 mm
L3	25,6 mm
h	65 mm
K h7	16 mm
a	500 mm
Net weight	79 kg
Gross weight	87,00 kg
EAN Code	8012667254018

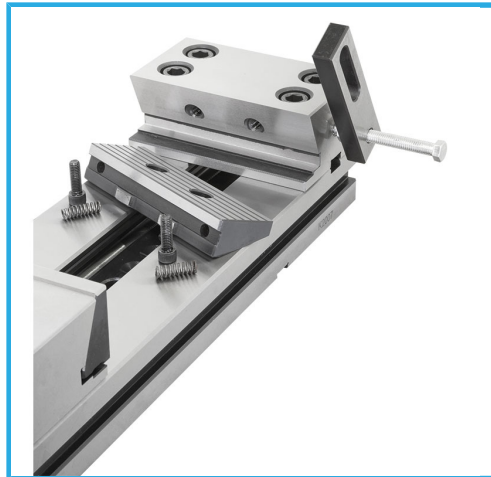
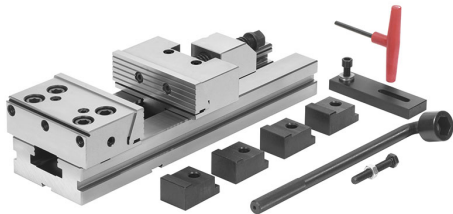

Wooden Box



Tempered



Grounded



Steel