

FOR QUICK TOOL CHANGES THANKS TO THE LOCK / UNLOCK LEVER.  
COMPOSED OF: - 1 TOOL POST - 4 FLAT TYPE TOOL HOLDERS.

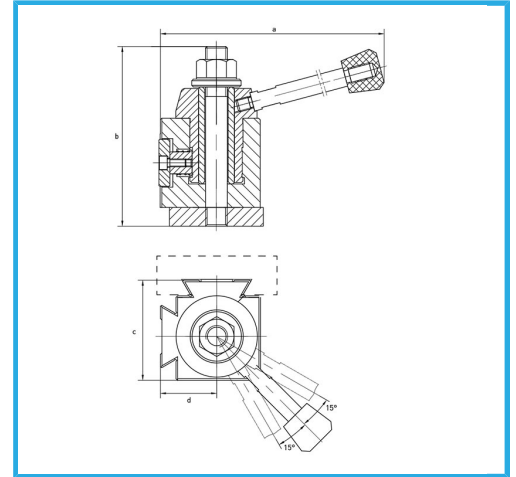

<b>Length</b>	95 mm
<b>Width</b>	85 mm
<b>Height</b>	76 mm
<b>Hole</b>	19,9 mm
<b>Tool height</b>	20 mm
<b>Gross weight</b>	10,75 kg
<b>EAN Code</b>	8012667213718

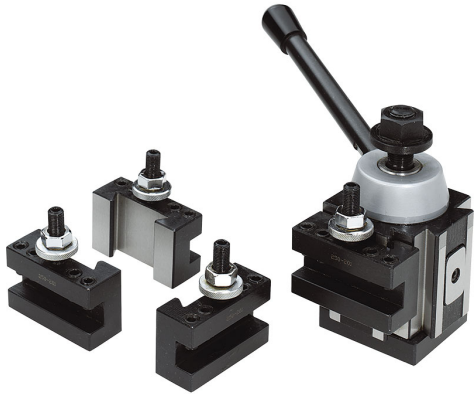

Box