

TYPE D EQUIPPED WITH SCREW FOR HEIGHT ADJUSTMENT AND 3 CLAMPING SCREWS.

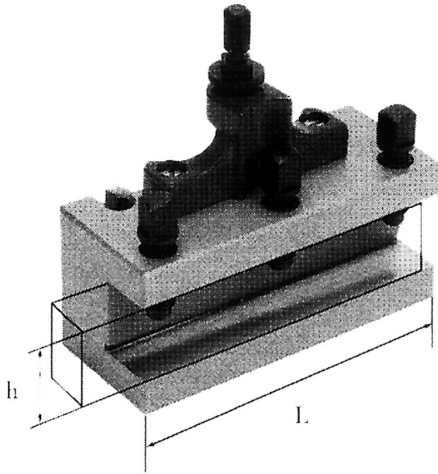

<b>L</b>	80 mm
<b>h</b>	16 mm
<b>Gross weight</b>	0,62 kg
<b>EAN Code</b>	8012667189990



Box