

TYPE S, SUITABLE FOR HOUSING MORSE TAPER BUSHES COD. C40142, AND FOR THE DIRECT HOUSING OF TURNING BARS. EQUIPPED WITH...

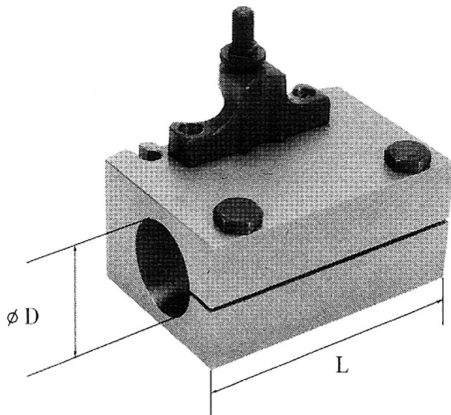

L	80 mm
D	30 mm
Gross weight	0,94 kg
EAN Code	8012667190552



Box