

TIPO S, ADATTO PER L'ALLOGGIAMENTO DI BUSSOLE A CONO MORSE
COD. C40142, E PER L'ALLOGGIAMENTO DIRETTO DI BARRE DI...

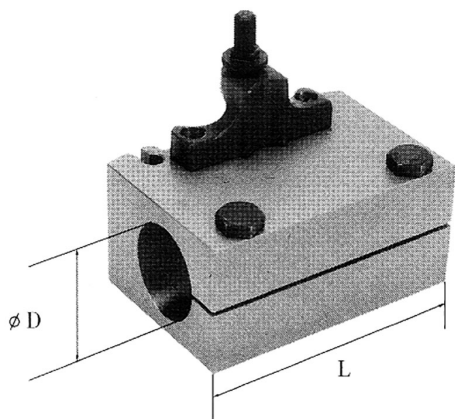

€142,00



L	80 mm
D	30 mm
Peso lordo	0,94 kg
Codice EAN	8012667190552



Scatola