

WITH HARDENED AND GROUND TOOTHING. BY ACTING ON AN ECCENTRIC PIN, THE TOOL HOLDER IS LOCKED ON THE TOOTHING OF THE BODY. IT...

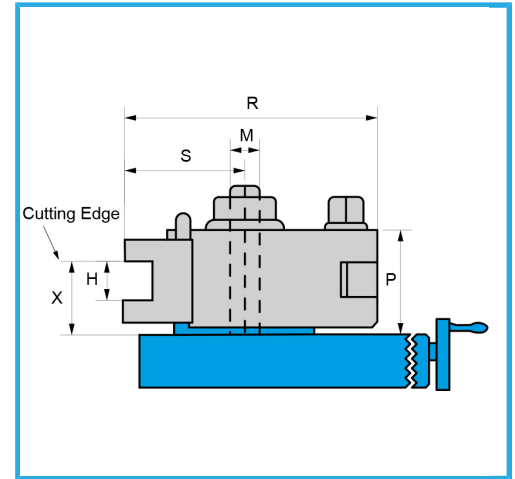

R max	150 mm
S max	75 mm
P	71 mm
h	25 mm
X min	37 mm
Gross weight	12,00 kg
EAN Code	8012667192792



Box