

TIPO S, ADATTO PER L'ALLOGGIAMENTO DI BUSSOLE A CONO MORSE
COD. C40142, E PER L'ALLOGGIAMENTO DIRETTO DI BARRE DI...

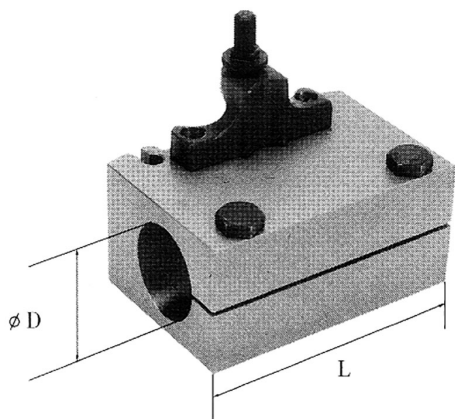

€235,00



L	120 mm
D	40 mm
Peso lordo	2,71 kg
Codice EAN	8012667188887



Scatola