

TYPE D EQUIPPED WITH SCREW FOR HEIGHT ADJUSTMENT AND 3 CLAMPING SCREWS.

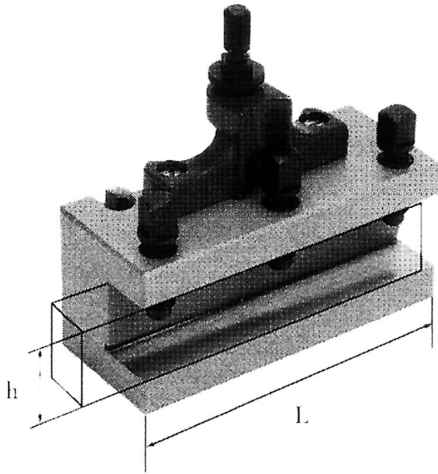

L	100 mm
h	20 mm
Gross weight	1,10 kg
EAN Code	8012667192242



Box