

TYPE S, SUITABLE FOR HOUSING MORSE TAPER BUSHES COD. C40142, AND FOR THE DIRECT HOUSING OF TURNING BARS. EQUIPPED WITH...

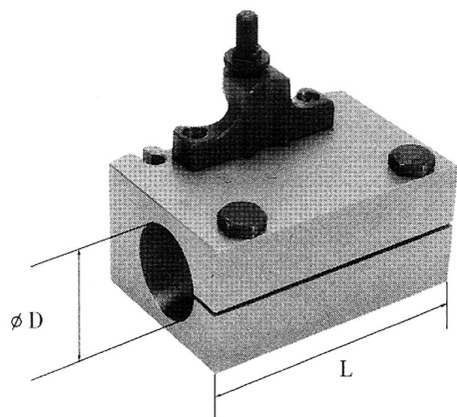

<b>L</b>	100 mm
<b>D</b>	30 mm
<b>Gross weight</b>	1,53 kg
<b>EAN Code</b>	8012667192808



Box