

TIPO S, ADATTO PER L'ALLOGGIAMENTO DI BUSSOLE A CONO MORSE
COD. C40142, E PER L'ALLOGGIAMENTO DIRETTO DI BARRE DI...

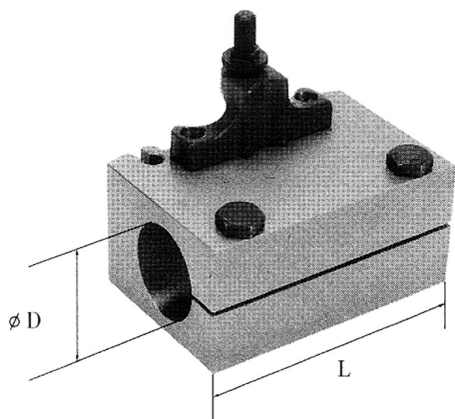

€191,00



L	100 mm
D	30 mm
Peso lordo	1,53 kg
Codice EAN	8012667192808



Scatola