

AUSGESTATTET MIT MIKROMETRISCHER VERSTELLUNG UND ÖLBADGETRIEBE.

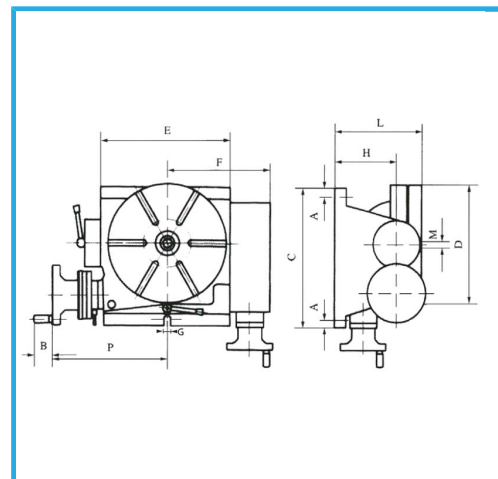

A	14 mm
B	40 mm
C	310 mm
D	250 mm
E	252 mm
F	199 mm
G	14 mm
H	140 mm
L	205 mm
CM	3
Übersetzungsverhältnis	1:90
Nute	6/12 N° / mm
max. horizontale Reichweite	200 kg
max. vertikale Reichweite	100 kg
Nettogewicht	78 kg
Bruttogewicht	90,00 kg
EAN-Code	8012667003074



Holzkasten