

EQUIPADO CON DE AJUSTE MICROMÉTRICO Y ENGRANAJES BAÑO DE ACEITE.

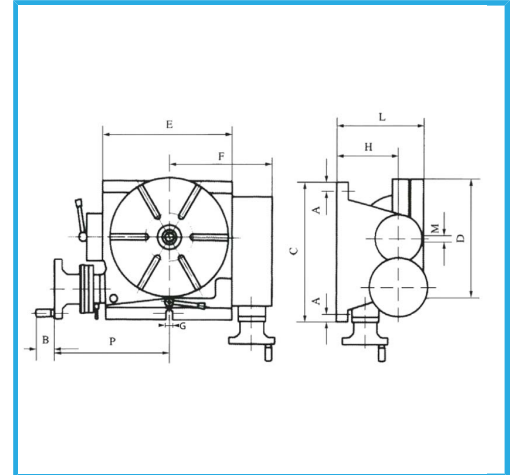

€2.720,00



A	14 mm
B	40 mm
C	310 mm
D	250 mm
E	252 mm
F	199 mm
G	14 mm
H	140 mm
L	205 mm
CM	3
Proporción	1:90
Ranuras	6/12 N° / mm
Capacidad máx. horizontal	200 kg
Capacidad máx. vertical	100 kg
Peso neto	78 kg
Peso bruto	90,00 kg
Codigo de barras	8012667003074



Caja de madera