

EQUIPADO CON DE AJUSTE MICROMÉTRICO Y ENGRANAJES BAÑO DE ACEITE.

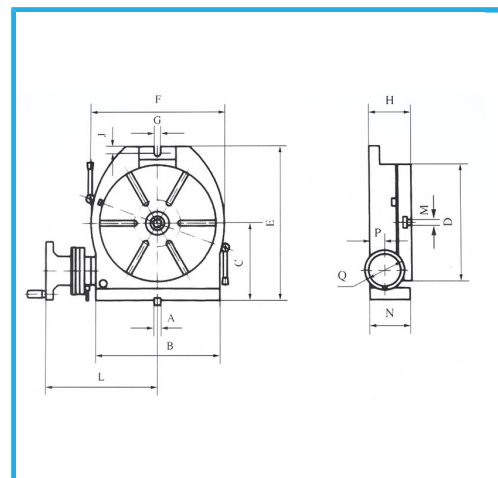

€844,00

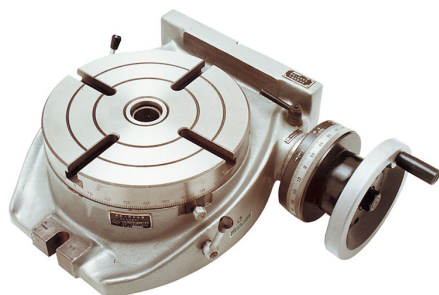

A	12 mm
B	186 mm
C	125 mm
D	160 mm
E	242 mm
F	196 mm
G	12 mm
H	85 mm
J	12 mm
L	194 mm
N	82 mm
P	37 mm
Cuadro	125 mm
CM	2
Proporción	1:90
Ranuras	4/10 N° / mm
Capacidad máx. horizontal	100 kg
Capacidad máx. vertical	50 kg
Peso neto	23 kg
Peso bruto	31,00 kg
Codigo de barras	8012667180287



Caja de madera