

AUSGESTATTET MIT MIKROMETRISCHER VERSTELLUNG UND ÖLBADGETRIEBE.

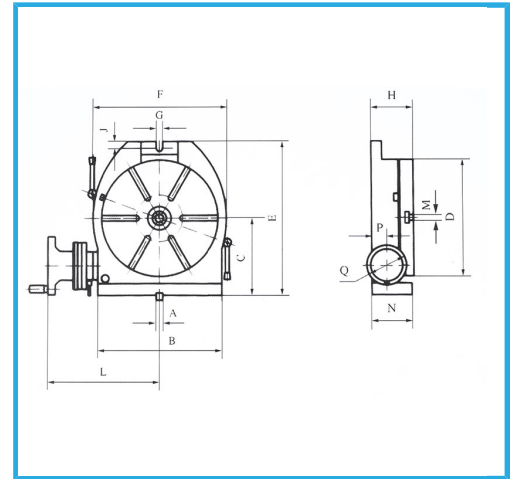

A	14 mm
B	208 mm
C	150 mm
D	200 mm
E	285 mm
F	236 mm
G	14 mm
H	100 mm
J	15 mm
L	211 mm
N	99 mm
P	48 mm
Q	125 mm
CM	3
Übersetzungsverhältnis	1:90
Nute	4/12 N° / mm
max. horizontale Reichweite	150 kg
max. vertikale Reichweite	75 kg
Nettogewicht	30 kg
Bruttogewicht	40,00 kg
EAN-Code	8012667003098

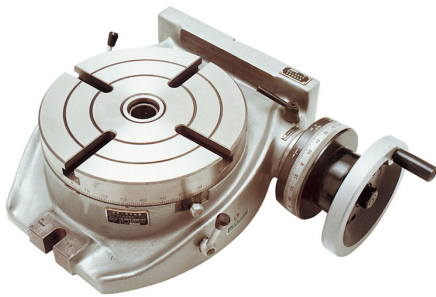

Holzkasten