

AUSGESTATTET MIT MIKROMETRISCHER VERSTELLUNG UND ÖLBADGETRIEBE.

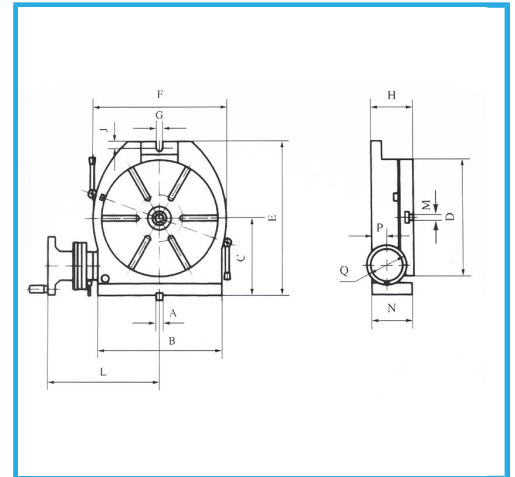

A	14 mm
B	253 mm
C	170 mm
D	250 mm
E	328 mm
F	286 mm
G	14 mm
H	110 mm
J	16 mm
L	241 mm
N	106 mm
P	48 mm
Q	125 mm
CM	4
Übersetzungsverhältnis	1:90
Nute	6/12 N° / mm
max. horizontale Reichweite	200 kg
max. vertikale Reichweite	100 kg
Nettogewicht	44 kg
Verpackungsmaße	505x455x240 h mm
Bruttogewicht	54,50 kg
EAN-Code	8012667003104

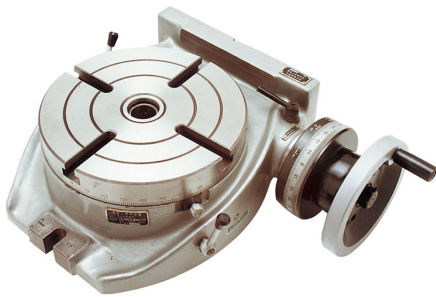

Holzkasten