

EQUIPPED WITH MICROMETRIC ADJUSTMENT AND OIL BATH GEARS.

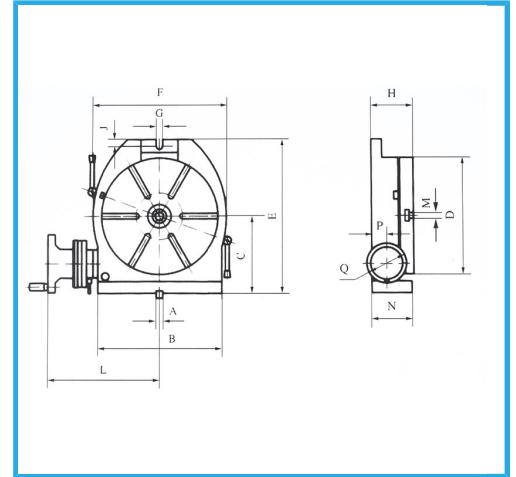

<b>A</b>	14 mm
<b>B</b>	253 mm
<b>C</b>	170 mm
<b>D</b>	250 mm
<b>E</b>	328 mm
<b>F</b>	286 mm
<b>G</b>	14 mm
<b>H</b>	110 mm
<b>J</b>	16 mm
<b>L</b>	241 mm
<b>N</b>	106 mm
<b>P</b>	48 mm
<b>Q</b>	125 mm
<b>MT</b>	4
<b>Ratio</b>	1:90
<b>Slots</b>	6/12 N° / mm
<b>Hor. max load</b>	200 kg
<b>Ver. max load</b>	100 kg
<b>Net weight</b>	44 kg
<b>Gross weight</b>	54,50 kg
<b>EAN Code</b>	8012667003104

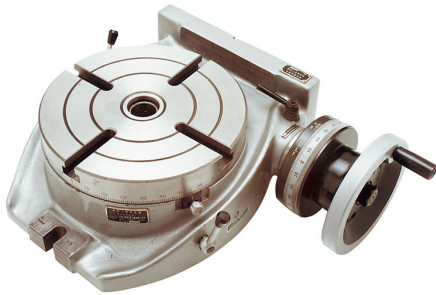

Wooden Box