

AUSGESTATTET MIT MIKROMETRISCHER VERSTELLUNG UND ÖLBADGETRIEBE.

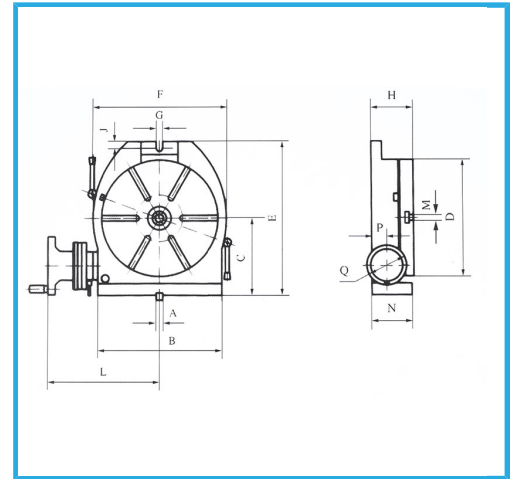

A	18 mm
B	321 mm
C	210 mm
D	320 mm
E	410 mm
F	360 mm
G	18 mm
H	120 mm
J	16 mm
L	273 mm
N	118 mm
P	48 mm
Q	125 mm
CM	4
Übersetzungsverhältnis	1:90
Nute	6/14 N° / mm
max. horizontale Reichweite	250 kg
max. vertikale Reichweite	125 kg
Nettogewicht	75 kg
Bruttogewicht	92,00 kg
EAN-Code	8012667003111

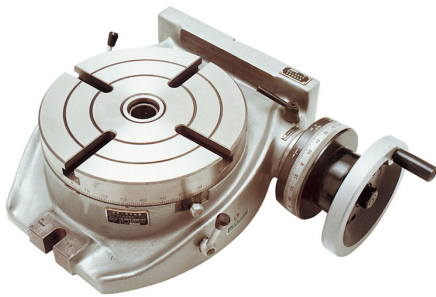

Holzkasten