

EQUIPADO CON DE AJUSTE MICROMÉTRICO Y ENGRANAJES BAÑO DE ACEITE.

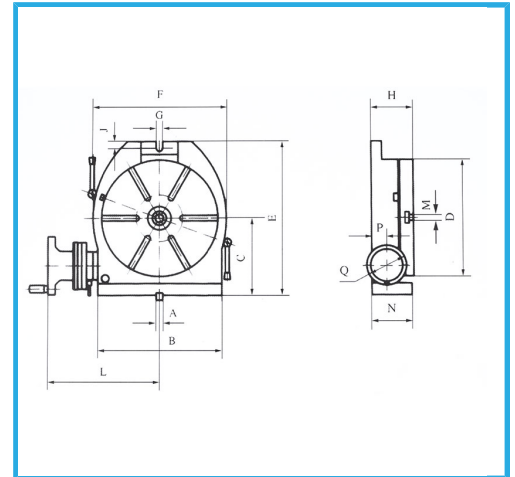

€1.680,00

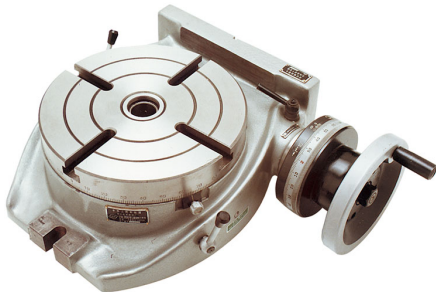

A	18 mm
B	321 mm
C	210 mm
D	320 mm
E	410 mm
F	360 mm
G	18 mm
H	120 mm
J	16 mm
L	273 mm
N	118 mm
P	48 mm
Cuadro	125 mm
CM	4
Proporción	1:90
Ranuras	6/14 N° / mm
Capacidad máx. horizontal	250 kg
Capacidad máx. vertical	125 kg
Peso neto	75 kg
Peso bruto	92,00 kg
Codigo de barras	8012667003111



Caja de madera