

DOTATA DI REGOLAZIONE MICROMETRICA ED INGRANAGGI A BAGNO  
D'OLIO.

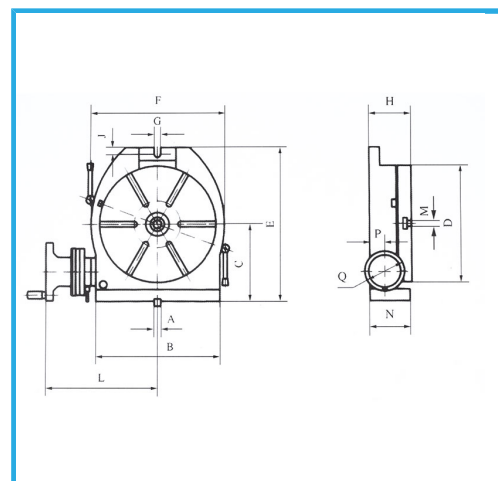

€1.680,00

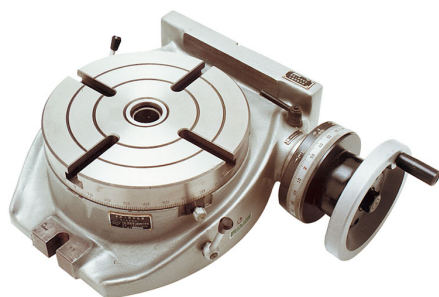

A	18 mm
B	321 mm
C	210 mm
D	320 mm
E	410 mm
F	360 mm
G	18 mm
H	120 mm
J	16 mm
L	273 mm
N	118 mm
P	48 mm
Q	125 mm
CM	4
Rapporto	1:90
Cave	6/14 N° / mm
Portata max orizzontale	250 kg
Portata max verticale	125 kg
Peso netto	75 kg
Peso lordo	92,00 kg
Codice EAN	8012667003111



Cassa di  
legno