

DIN 69871/A, AUSGEWUCHTETES SPANNFUTTERGEHÄUSE, FÜR
ZYLINDRISCHE SCHAFTFRÄSER NACH DIN 481, FÜR FRÄSER...

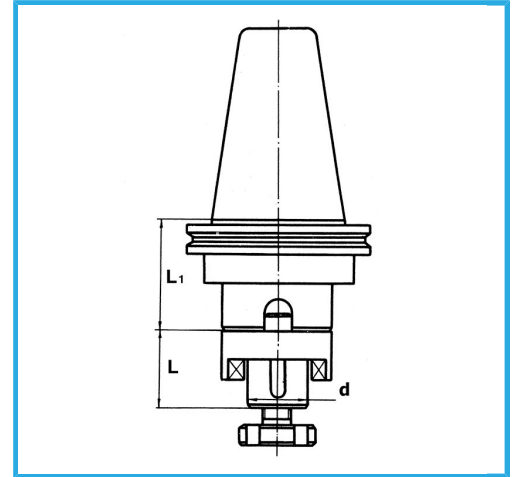

ISO	40
d-h6	16 mm
L	27 mm
L1	35 mm
Auswuchtdrehzahl rpm	12000
Bruttogewicht	1,18 kg
EAN-Code	8012667008031



Box

18Ni
CrMo5



Korrigiert