

DIN 69871/A, CON CUERPO EQUILIBRADO, PARA FRESAS CILÍNDRICAS SEGÚN DIN 481, PARA FRESAS CON RANURA LONGITUDINAL DIN...

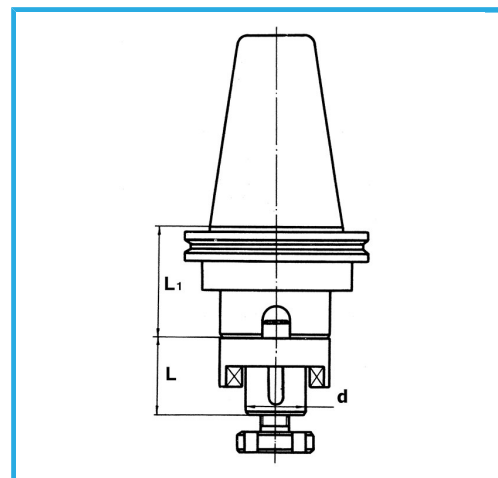

€119,00



ISO	40
Diámetro	16 mm
L	27 mm
L1	35 mm
Equilibrado rpm	12000
Peso bruto	1,18 kg
Codigo de barras	8012667008031



Caja

18Ni  
CrMo5



Rectificado