

DIN 69871/A, AUSGEWUCHTETES SPANNFUTTERGEHÄUSE, FÜR
ZYLINDRISCHE SCHAFTFRÄSER NACH DIN 481, FÜR FRÄSER...

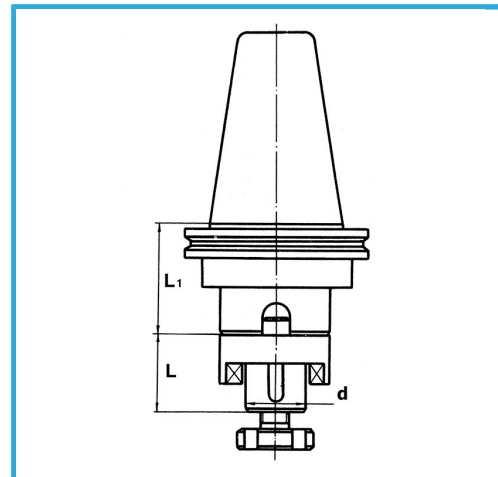

ISO	50
d-h6	27 mm
L	33 mm
L1	35 mm
Auswuchtdrehzahl rpm	12000
Bruttogewicht	3,30 kg
EAN-Code	8012667008147



Box

18Ni
CrMo5



Korrigiert