

DIN 69871/A, BALANCED CHUCK BODY, FOR CYLINDRICAL END MILLS  
ACCORDING TO DIN 481, FOR MILLING CUTTERS WITH LONGITUDINAL  
GROOVE...

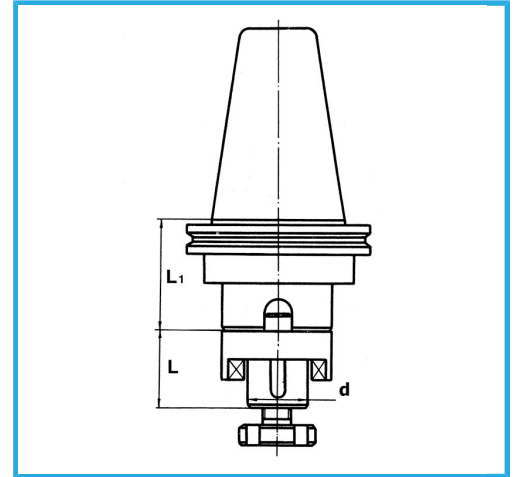

ISO	50
d-h6	27 mm
L	33 mm
L1	35 mm
Balancing rpm	12000
Gross weight	3,30 kg
EAN Code	8012667008147



Box

18Ni  
CrMo5



Grounded