

DIN 69871/A, CON CUERPO EQUILIBRADO, PARA FRESAS CILÍNDRICAS SEGÚN DIN 481, PARA FRESAS CON RANURA LONGITUDINAL DIN...

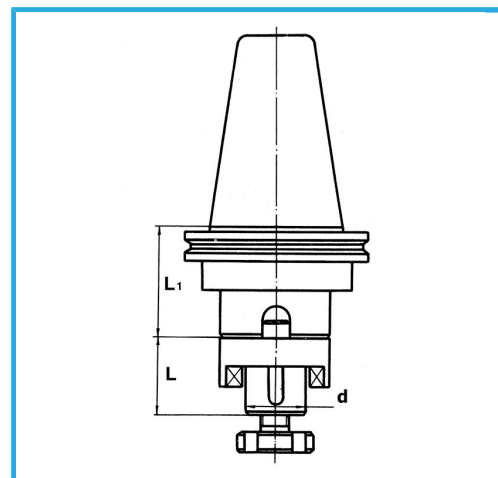

€165,00



ISO	50
Diámetro	27 mm
L	33 mm
L1	35 mm
Equilibrado rpm	12000
Peso bruto	3,30 kg
Codigo de barras	8012667008147



Caja

18Ni
CrMo5



Rectificado