

DIN 69871/A, CORPO MANDRINO BILANCIATO, PER FRESE
CILINDRICHE FRONTALI SECONDO NORMA DIN 481, PER FRESE CON
SCANALATURA...

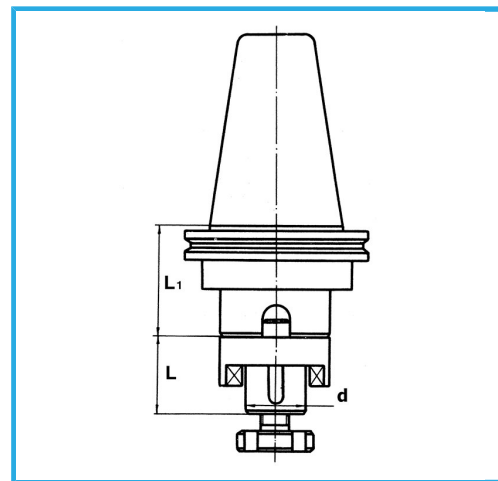

€165,00



ISO	50
d-h6	27 mm
L	33 mm
L1	35 mm
Equilibratura rpm	12000
Peso lordo	3,30 kg
Codice EAN	8012667008147



Scatola

18Ni
CrMo5



Rettificato