

DIN 69871/A, AUSGEWUCHTETES SPANNFUTTERGEHÄUSE, FÜR
ZYLINDRISCHE SCHAFTFRÄSER NACH DIN 481, FÜR FRÄSER...

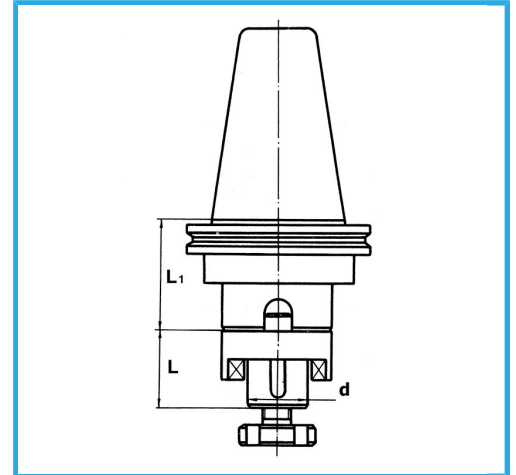

ISO	40
d-h6	32 mm
L	38 mm
L1	45 mm
Auswuchtdrehzahl rpm	12000
Bruttogewicht	1,70 kg
EAN-Code	8012667008062



Box

18Ni
CrMo5



Korrigiert