

DIN 69871/A, CON CUERPO EQUILIBRADO, PARA FRESAS CILÍNDRICAS SEGÚN DIN 481, PARA FRESAS CON RANURA LONGITUDINAL DIN...

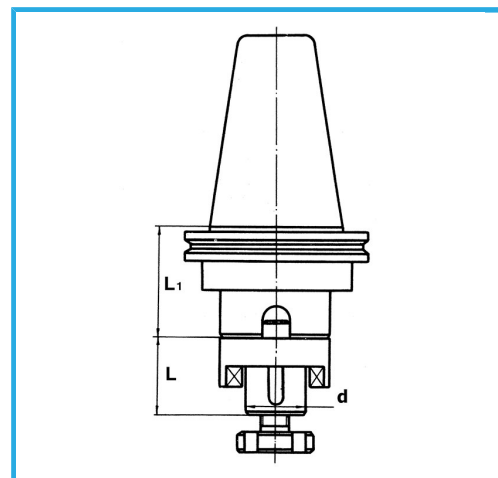

€132,00



ISO	40
Diámetro	32 mm
L	38 mm
L1	45 mm
Equilibrado rpm	12000
Peso bruto	1,70 kg
Codigo de barras	8012667008062



Caja

18Ni  
CrMo5



Rectificado