

DIN 69871/A, CORPO MANDRINO BILANCIATO, PER FRESE
CILINDRICHE FRONTALI SECONDO NORMA DIN 481, PER FRESE CON
SCANALATURA...

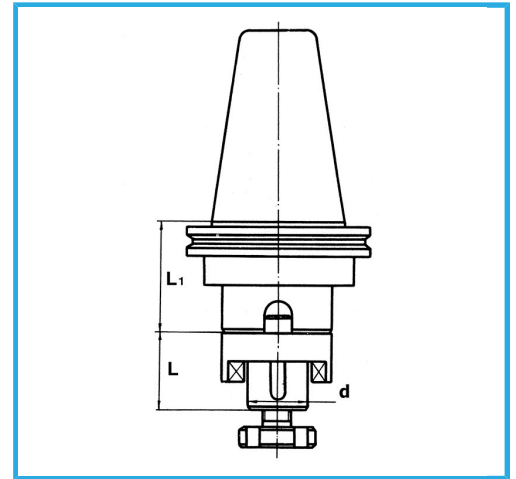

€132,00



| | |
|-------------------|---------------|
| ISO | 40 |
| d-h6 | 32 mm |
| L | 38 mm |
| L1 | 45 mm |
| Equilibratura rpm | 12000 |
| Peso lordo | 1,70 kg |
| Codice EAN | 8012667008062 |



Scatola

18Ni
CrMo5



Rettificato