

DIN 69871/A, AUSGEWUCHTETES SPANNFUTTERGEHÄUSE, FÜR  
ZYLINDRISCHE SCHAFTFRÄSER NACH DIN 481, FÜR FRÄSER...

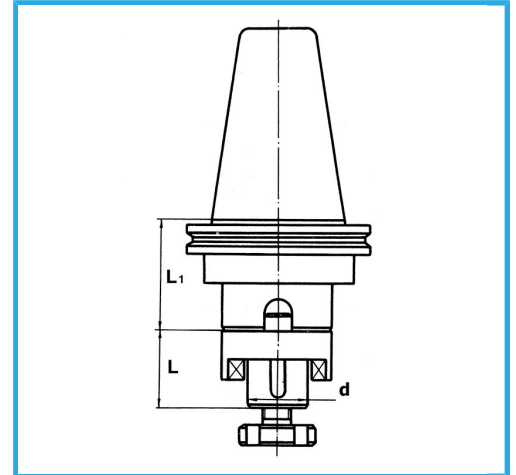

ISO	50
d-h6	32 mm
L	38 mm
L1	40 mm
Auswuchtdrehzahl rpm	12000
Bruttogewicht	4,94 kg
EAN-Code	8012667008154



Box

18Ni  
CrMo5



Korrigiert