

DIN 69871/A, CON CUERPO EQUILIBRADO, PARA FRESAS CILÍNDRICAS SEGÚN DIN 481, PARA FRESAS CON RANURA LONGITUDINAL DIN...

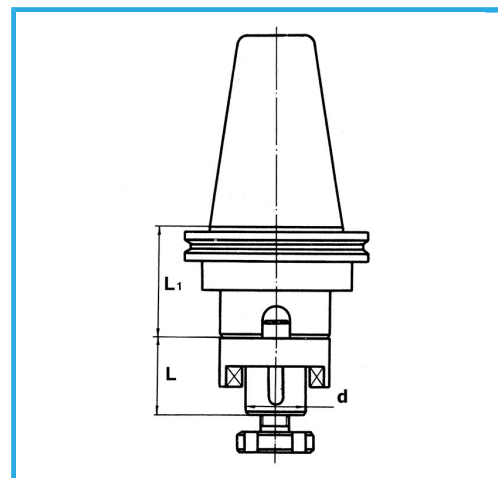

€176,00



ISO	50
Diámetro	32 mm
L	38 mm
L1	40 mm
Equilibrado rpm	12000
Peso bruto	4,94 kg
Codigo de barras	8012667008154



Caja

18Ni
CrMo5



Rectificado