

DIN 69871/A, AUSGEWUCHTETES SPANNFUTTERGEHÄUSE, FÜR
FRÄSER (WELDON) NACH DIN 1835 B UND DIN 6535 HB. LIEFERUNG...

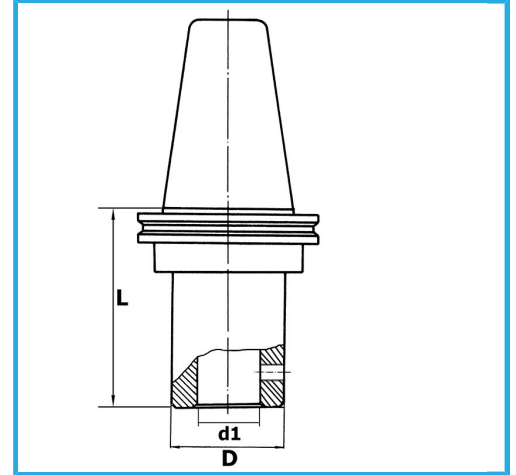

ISO	40
d1 - h6	6 mm
D	25 mm
L	60 mm
Bruttogewicht	0,95 kg
EAN-Code	8012667195489



Box



Korrigiert



18Ni
CrMo5

-