

DIN 69871/A, CORPO MANDRINO BILANCIATO, PER FRESE (WELDON)  
SECONDO NORMA DIN 1835 B E DIN 6535 HB. FORNITO CON VITE DI...

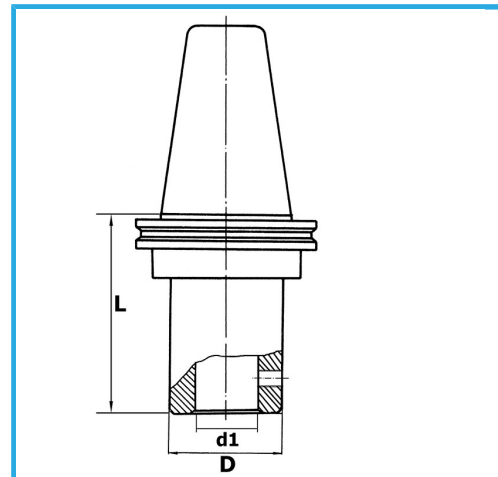

€133,00



ISO	50
d1 - h6	6 mm
D	25 mm
L	65 mm
Peso lordo	2,82 kg
Codice EAN	8012667193034



Scatola



Rettificato

18Ni  
CrMo5