

DIN 69871/A, AUSGEWUCHTETES SPANNFUTTERGEHÄUSE, FÜR
FRÄSER (WELDON) NACH DIN 1835 B UND DIN 6535 HB. LIEFERUNG...

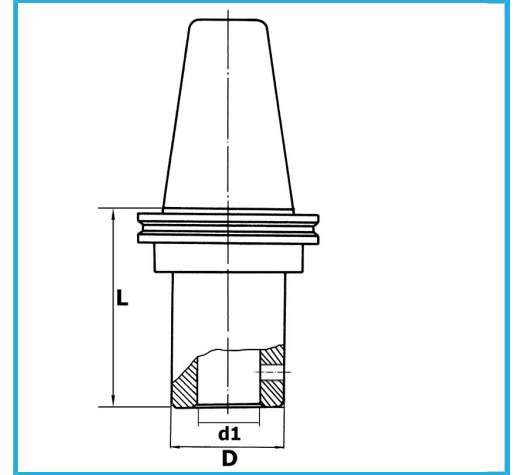

ISO	50
d1 - h6	8 mm
D	28 mm
L	65 mm
Bruttogewicht	3,69 kg
EAN-Code	8012667193065



Box



Korrigiert



18Ni
CrMo5

-