

DIN 69871/A, AUSGEWUCHTETES SPANNFUTTERGEHÄUSE, FÜR  
FRÄSER (WELDON) NACH DIN 1835 B UND DIN 6535 HB. LIEFERUNG...

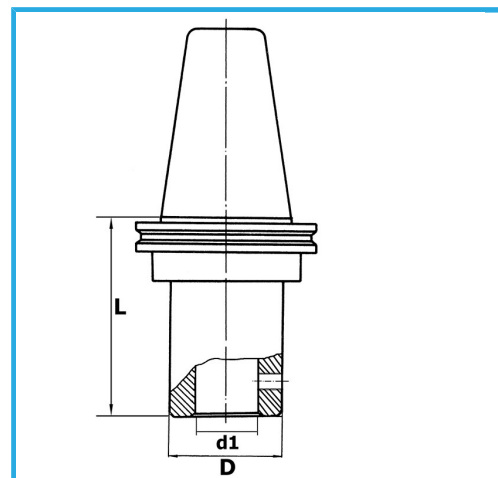

ISO	40
d1 - h6	10 mm
D	35 mm
L	50 mm
Bruttogewicht	1,03 kg
EAN-Code	8012667195502



Box



Korrigiert



18Ni  
CrMo5

-