

DIN 69871/A, CON CUERPO EQUILIBRADO, PARA FRESAS (WELDON)  
SEGÚN DIN 1835 B Y DIN 6535 HB. SE SUMINISTRA CON TORNILLO  
DE...

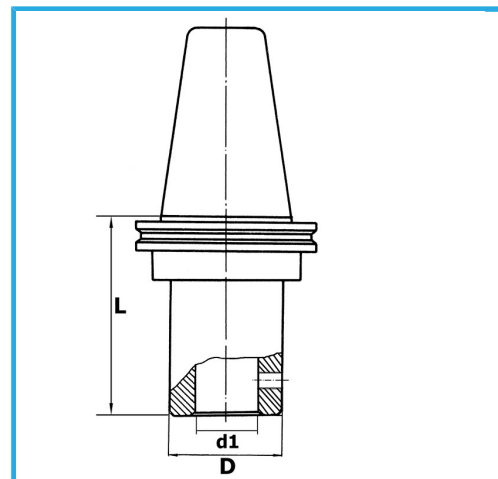

€133,00



ISO	50
d1 - h6	10 mm
D	35 mm
L	70 mm
Peso bruto	3,00 kg
Codigo de barras	8012667193096



Caja



Rectificado

18Ni  
CrMo5

-